

MH2321-D9

Premium 18 Gauge 304 Stainless Steel Single Bowl Undermount Sink

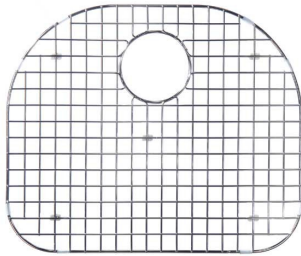

BG21S GRID
Optional



Sink Strainer
Optional

Model: MH2321-D9

Dimensions

- Overall Size: 23 1/2" x 21"
- Bowl Size: 21-1/2" x 19" x 9" D
- Drain Opening: 3 1/2"

Optional Accessories

- Single Grid: BG21S
- Sink Strainer

Features

- 18 gauge 304 stainless steel
- Proprietary V-Therm Shield™
- Provides superior sound deadening and thermal retention.
- High luster satin finish
- Stain and corrosion resistant



Complies with ASME A112.19.3-2000

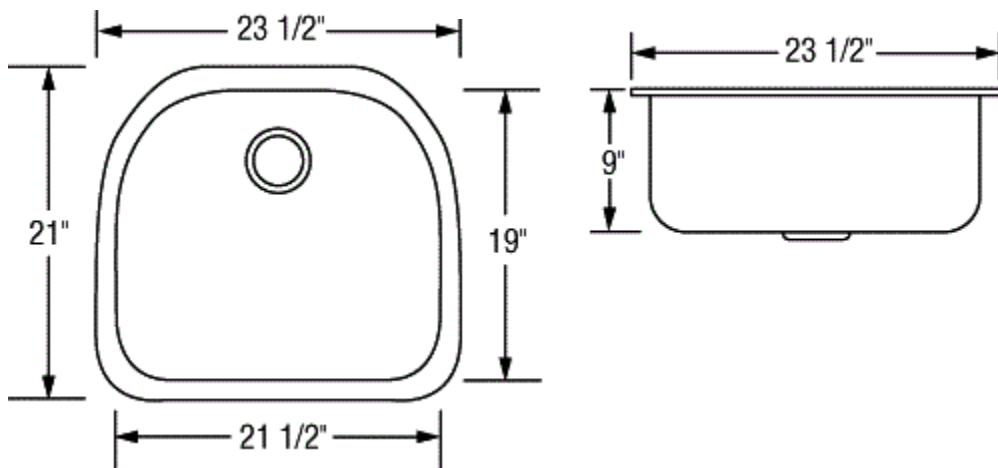

Product Specification

The undermount sink shall be 23 1/2" in length and 21" in width. Sink shall be made of 18 gauge stainless steel. Sink shall have brushed finished rim. Sink shall be a single bowl. Sink shall be an Artisan model MH2321-D9.